



ORIGINAL

No. 114169

भारत सरकार
GOVERNMENT OF INDIA
पेटेंट कार्यालय
THE PATENT OFFICE

CERTIFICATE OF REGISTRATION OF DESIGN

Design No. 360065-001
Date 07/03/2022 19:53:12
Reciprocity Date*
Country

Certified that the design of which a copy is annexed hereto has been registered as of the number and date given above in class 10-05 in respect of the application of such design to INTELLIGENT VEHICLE DRIVER DROWSINESS DETECTING & ALERTING DEVICE in the name of 1.DR. AMIT KUMAR BANSAL, PROFESSOR, JBIT, DEHRADUN, UTTARAKHAND 2. DR. VISHANT KUMAR, PROFESSOR, JBIT, DEHRADUN, UTTARAKHAND 3. DR. ANIRUDH GUPTA, PROFESSOR, BTKIT DWARHAT, UTTARAKHAND 4. DR. CHANDRA KISHORE GUPTA, ASSO. PROFESSOR, GEU DEHRADUN, UTTARAKHAND, ET AL.

in pursuance of and subject to the provisions of the Designs Act, 2000 and the Designs Rules, 2001.

Controller General of Patents, Designs and Trade Marks

*The reciprocity date (if any) which has been allowed and the name of the country.
Copyright in the design will subsist for ten years from the date of Registration, and may under the terms of the Act and Rules, be extended for a further period of five years.
This Certificate is not for use in legal proceedings or for obtaining registration abroad

SAURABH KUMAR JAIN,
SENANIP, F-440, DELTA-1, GREATER NOIDA, UP
201310 INDIA

Date of Issue 25/05/2022 15:31:53

INTELLECTUAL
PROPERTY INDIA
PATENTS | DESIGNS | TRADE MARKS
GEOGRAPHICAL INDICATIONS

DESIGN NUMBER	360059-001	
CLASS	10-07	
CASIO KEISANKI KABUSHIKI KAISHA DOING BUSINESS AS CASIO COMPUTER CO., LTD 6-2 HON-MACHU 1-CHOME, SHIBUYA-KU, TOKYO, JAPAN		
DATE OF REGISTRATION	07/03/2022	
TITLE	WATCH CASE WITH WATCHBAND	
PRIORITY		
PRIORITY NUMBER	DATE	COUNTRY
2021-022615	18/10/2021	JAPAN

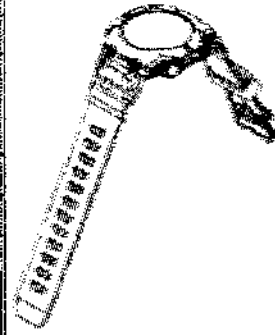

DESIGN NUMBER	360064-001	
CLASS	24-01	
1. DR VIVEK GARG RESEARCH AND CONSULTING ENGINEER, THE WOLFSON CENTRE FOR BULK SOLIDS HANDLING TECHNOLOGY UNIVERSITY OF GREENWICH, UNITED KINGDOM 2. DR LUCAS MASSARO SOUSA CONSULTING ENGINEER, THE WOLFSON CENTRE FOR BULK SOLIDS HANDLING TECHNOLOGY, UNIVERSITY OF GREENWICH, UNITED KINGDOM 3. PROF. MICHAEL BRADLEY DIRECTOR, THE WOLFSON CENTRE FOR BULK SOLIDS HANDLING TECHNOLOGY, UNIVERSITY OF GREENWICH, UNITED KINGDOM 4. BINU KURIAKOSE VARGIS KIZHAKEDATHU HOUSE ITC ROAD, NEAR CHURCH, MANARCAD P.O, KOTTAYAM, KERALA 686019, INDIA		
DATE OF REGISTRATION	07/03/2022	
TITLE	MEDICAL SUCTION PUMP CONTROLLER	
PRIORITY NA		

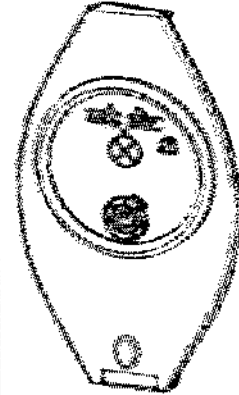

DESIGN NUMBER	360065-001	
CLASS	10-05	
1. DR. AMIT KUMAR BANSAL PROFESSOR, JBIT, DEHRADUN, UTTARAKHAND 2. DR. VISHANT KUMAR PROFESSOR, JBIT, DEHRADUN, UTTARAKHAND 3. DR. ANIRUDDH GUPTA PROFESSOR, BIKIT DWARHAT, UTTARAKHAND 4. DR. CHANDRA KISHORE GUPTA ASSO. PROFESSOR, CEU DEHRADUN, UTTARAKHAND, ET AL.		
DATE OF REGISTRATION	07/03/2022	
TITLE	INTELLIGENT VEHICLE DRIVER DROWSINESS DETECTING & ALERTING DEVICE	
PRIORITY NA		



Design Application Details

Application Number: 360065-001
Cbr Number: 214388
Cbr Date: 07/03/2022 19:53:12
Applicant Name:

1. Dr. Amit Kumar Bansal
2. Dr. Vishant Kumar
3. Dr. Anirudh Gupta
4. Dr. Chandra Kishore Gupta
5. Mr. Manoj Chaudhary
6. Mr. Punit Kumar
7. Mr. Sumit Sangwan

Design Application Status

Application Status: Design Accepted and Published, Journal No is 21/2022 and Journal E



Controller General of Patents, Designs and Trademarks
Department of Industrial Policy and Promotion
Ministry of Commerce and Industry

Design Application Details

Application Number:

360065-001

Cbr Number:

214388

Cbr Date:

07/03/2022 19:53:12

Applicant Name:

- 1. Dr. Amit Kumar Bansal 2. Dr. Vishant Kumar 3. Dr. Anirudh Gupta
- 4. Dr. Chandra Kishore Gupta 5. Mr. Manoj Chaudhary 6. Mr. Punit Kumar
- 7. Mr. Sumit Sangwan

Design Application Status

Application Status:

Design Accepted and Published, Journal No is 21/2022 and Journal Date is 27/05/2022

[Back \(/DesignApplicationStatus/\)](#)

(SPECIMEN OF REPRESENTATION SHEETS)

Name of Applicant:

- | | | |
|---------------------------|------------------------------|-------------------------------|
| 1. Dr. Amit Kumar Bansal, | 2. Dr. Vishant Kumar | Total Pages: 6
Page 1 of 6 |
| 3. Dr. Anirudh Gupta | 4. Dr. Chandra Kishore Gupta | |
| 5. Mr. Manoj Chaudhary | 6. Mr. Punit Kumar | |



PERSPECTIVE VIEW

The novelty resides in the shape and configuration of the “**INTELLIGENT VEHICLE DRIVER DROWSINESS DETECTING & ALERTING DEVICE**” as illustrated.

No claim is made by virtue of this registration in respect of any mechanical or other action of any mechanism whatever or in respect of any mode or principle of construction of the Article.

No claim is made by virtue of this registration to any right to the exclusive use of the words, letters, numbers, or trade marks appearing in the representation.

Dated 7th March, 2022

Signature of the Agent
Saurabh Kumar Jain, (IN/PA-3637)

(SPECIMEN OF REPRESENTATION SHEETS)

Name of Applicant:

- | | | |
|---------------------------|------------------------------|-------------------------------|
| 1. Dr. Amit Kumar Bansal, | 2. Dr. Vishant Kumar | Total Pages: 6
Page 2 of 6 |
| 3. Dr. Anirudh Gupta | 4. Dr. Chandra Kishore Gupta | |
| 5. Mr. Manoj Chaudhary | 6. Mr. Punit Kumar | |

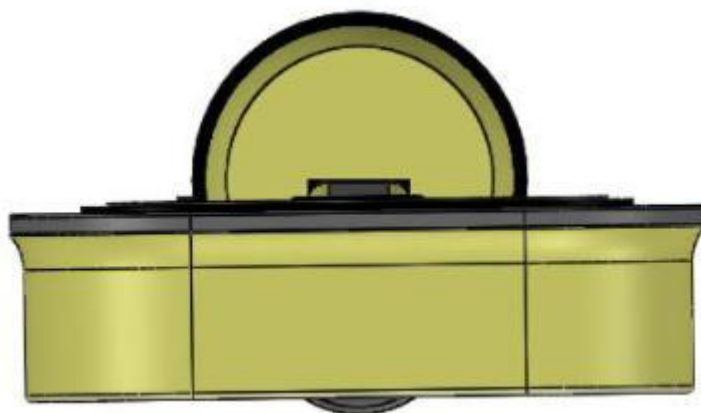

TOP VIEW

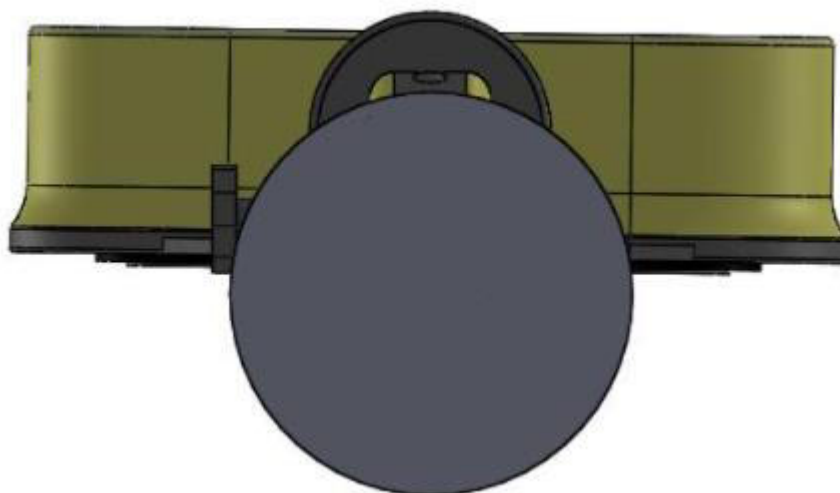

BOTTOM VIEW

The novelty resides in the shape and configuration of the “**INTELLIGENT VEHICLE DRIVER DROWSINESS DETECTING & ALERTING DEVICE**” as illustrated.

No claim is made by virtue of this registration in respect of any mechanical or other action of any mechanism whatever or in respect of any mode or principle of construction of the Article.

No claim is made by virtue of this registration to any right to the exclusive use of the words, letters, numbers, or trade marks appearing in the representation.

Dated 7th March, 2022

Signature of the Agent

Saurabh Kumar Jain, (IN/PA-3637)

(SPECIMEN OF REPRESENTATION SHEETS)

Name of Applicant:

- | | | |
|---------------------------|------------------------------|----------------------|
| 1. Dr. Amit Kumar Bansal, | 2. Dr. Vishant Kumar | Total Pages: 6 |
| 3. Dr. Anirudh Gupta | 4. Dr. Chandra Kishore Gupta | Page 3 of 6 |
| 5. Mr. Manoj Chaudhary | 6. Mr. Punit Kumar | 7. Mr. Sumit Sangwan |



FRONT VIEW

The novelty resides in the shape and configuration of the “**INTELLIGENT VEHICLE DRIVER DROWSINESS DETECTING & ALERTING DEVICE**” as illustrated.

No claim is made by virtue of this registration in respect of any mechanical or other action of any mechanism whatever or in respect of any mode or principle of construction of the Article.

No claim is made by virtue of this registration to any right to the exclusive use of the words, letters, numbers, or trade marks appearing in the representation.

Dated 7th March, 2022

Signature of the Agent
Saurabh Kumar Jain, (IN/PA-3637)

(SPECIMEN OF REPRESENTATION SHEETS)

Name of Applicant:

- | | | |
|---------------------------|------------------------------|-------------------------------|
| 1. Dr. Amit Kumar Bansal, | 2. Dr. Vishant Kumar | Total Pages: 6
Page 4 of 6 |
| 3. Dr. Anirudh Gupta | 4. Dr. Chandra Kishore Gupta | |
| 5. Mr. Manoj Chaudhary | 6. Mr. Punit Kumar | |

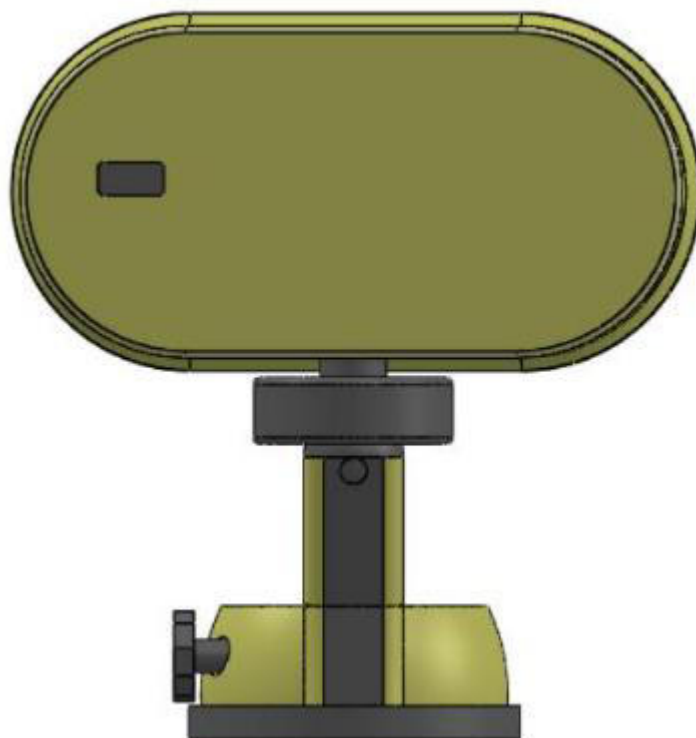

REAR VIEW

The novelty resides in the shape and configuration of the “**INTELLIGENT VEHICLE DRIVER DROWSINESS DETECTING & ALERTING DEVICE**” as illustrated.

No claim is made by virtue of this registration in respect of any mechanical or other action of any mechanism whatever or in respect of any mode or principle of construction of the Article.

No claim is made by virtue of this registration to any right to the exclusive use of the words, letters, numbers, or trade marks appearing in the representation.

Dated 7th March, 2022

Signature of the Agent

Saurabh Kumar Jain, (IN/PA-3637)

(SPECIMEN OF REPRESENTATION SHEETS)

Name of Applicant:

- | | | |
|---------------------------|------------------------------|----------------------|
| 1. Dr. Amit Kumar Bansal, | 2. Dr. Vishant Kumar | Total Pages: 6 |
| 3. Dr. Anirudh Gupta | 4. Dr. Chandra Kishore Gupta | Page 5 of 6 |
| 5. Mr. Manoj Chaudhary | 6. Mr. Punit Kumar | 7. Mr. Sumit Sangwan |

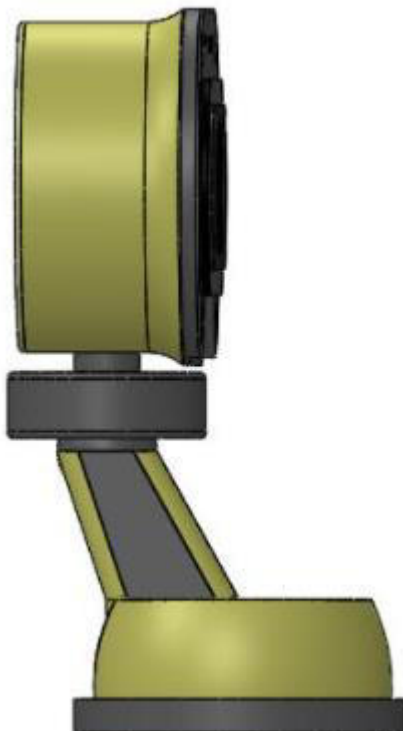

LEFT SIDE VIEW

The novelty resides in the shape and configuration of the “**INTELLIGENT VEHICLE DRIVER DROWSINESS DETECTING & ALERTING DEVICE**” as illustrated.

No claim is made by virtue of this registration in respect of any mechanical or other action of any mechanism whatever or in respect of any mode or principle of construction of the Article.

No claim is made by virtue of this registration to any right to the exclusive use of the words, letters, numbers, or trade marks appearing in the representation.

Dated 7th March, 2022

Signature of the Agent
Saurabh Kumar Jain, (IN/PA-3637)

(SPECIMEN OF REPRESENTATION SHEETS)

Name of Applicant:

- | | | |
|---------------------------|------------------------------|----------------------|
| 1. Dr. Amit Kumar Bansal, | 2. Dr. Vishant Kumar | Total Pages: 6 |
| 3. Dr. Anirudh Gupta | 4. Dr. Chandra Kishore Gupta | Page 6 of 6 |
| 5. Mr. Manoj Chaudhary | 6. Mr. Punit Kumar | 7. Mr. Sumit Sangwan |

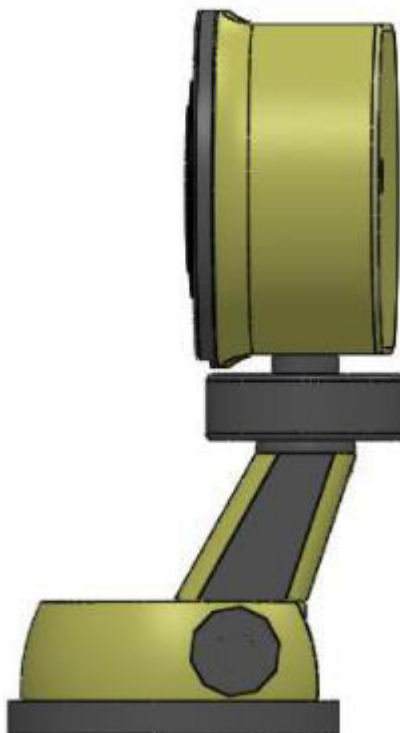

RIGHT SIDE VIEW

The novelty resides in the shape and configuration of the “**INTELLIGENT VEHICLE DRIVER DROWSINESS DETECTING & ALERTING DEVICE**” as illustrated.

No claim is made by virtue of this registration in respect of any mechanical or other action of any mechanism whatever or in respect of any mode or principle of construction of the Article.

No claim is made by virtue of this registration to any right to the exclusive use of the words, letters, numbers, or trade marks appearing in the representation.

Dated 7th March, 2022

Signature of the Agent
Saurabh Kumar Jain, (IN/PA-3637)