

Welcome Anuj Raturi [Sign out](#)

Controller General of Patents, Designs & Trade
Marks
Plot No. 32, Sector 14, Dwarka, New Delhi-110075
Tel No. (091)(011) 28034304-06 Fax No. 011
28034301,02
E-mail: delhi-patent@nic.in
Web Site: www.ipindia.gov.in

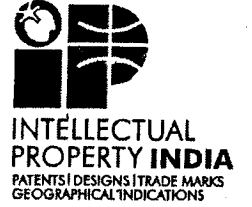

सत्यमेव जयते
G.A.R.6
[See Rule 22(1)]
RECEIPT



Docket No 131505

Date/Time 2022/11/24 07:13:35

To
Anuj Raturi

Userid: Anuj001

Gyananand Bhawan, Kalinka Vihar, Lane
No. 3, Majrimafi, IIP Mohkampur Kala-
248005, Dehradun, Uttarakhand, India

CBR Detail:

Sr. No.	Ref. No./Application No.	App. Number	Amount Paid	C.B.R. No.	Form Name	Remarks
1	E-106/7440/2022/DEL	202211067477	0	----	FORM28	
2	E-12/6333/2022/DEL	202211067477	2500	45952	FORM 9	----
3	202211067477	TEMP/E-1/77720/2022-DEL	1600	45952	FORM 1	A PHYSIOTHERAPY APPARATUS

TransactionID	Payment Mode	Challan Identification Number	Amount Paid	Head of A/C No
N-0001057338	Online Bank Transfer	2411220000589	4100.00	1475001020000001

Total Amount : ₹ 4100.00

Amount in Words: Rupees Four Thousand One Hundred Only

Received from Anuj Raturi the sum of ₹ 4100.00 on account of Payment of fee for above mentioned Application/Forms.

* This is a computer generated receipt, hence no signature required.

[Print](#)[Home](#)[About Us](#)[Contact Us](#)

(12) PATENT APPLICATION PUBLICATION

(21) Application No.202211067477 A

(19) INDIA

(22) Date of filing of Application :24/11/2022

(43) Publication Date : 09/12/2022

(54) Title of the invention : A PHYSIOTHERAPY APPARATUS

(51) International classification :F16M0013020000, A61B0017000000, A61B0034000000, H01Q0001500000, F16C0033660000

(86) International Application No :NA
Filing Date :NA

(87) International Publication No : NA

(61) Patent of Addition to Application Number :NA
Filing Date :NA

(62) Divisional to Application Number :NA
Filing Date :NA

(71)Name of Applicant :

1)J B INSTITUTE OF TECHNOLOGY

Address of Applicant :NH-72, VILLAGE SHANKARPUR, CHAKRATA ROAD, DEHRADUN, Uttarakhand, 248197, India. Dehradun -----

Name of Applicant : NA
Address of Applicant : NA

(72)Name of Inventor :

1)Dr. Arun Kumar Maurya

Address of Applicant :JBIT College of Pharmacy, Dehradun, Uttarakhand. Dehradun -----

2)Lalit Bisht

Address of Applicant :JBIT College of Pharmacy, Dehradun, Uttarakhand. Dehradun -----

3)Dr. Swati Tripathi

Address of Applicant :Department of Electrical Engineering, JB Institute of Technology, Dehradun. Dehradun -----

(57) Abstract :

The present invention relates to an apparatus for eradicating the stiffness of joints specifically the elbow and wrist. Said apparatus comprises of a ball bearing pulley; an oval suspend configured with the ball bearing pulley to form a hanging assembly; A length of cable configured around the pulley; a first lever and a second lever attached with the both ends of the ball bearing pulley and a plurality transverse members configured in between the first half and the second half of the cable.

No. of Pages : 15 No. of Claims : 7

FORM 1 THE PATENTS ACT 1970 (39 of 1970) and THE PATENTS RULES, 2003 APPLICATION FOR GRANT OF PATENT (See section 7, 54 and 135 and sub-rule (1) of rule 20)				(FOR OFFICE USE ONLY)	
				Application No.	
				Filing date:	
				Amount of Fee paid:	
				CBR No:	
				Signature:	
1. APPLICANT'S REFERENCE / IDENTIFICATION NO. (AS ALLOTTED BY OFFICE)					
2. TYPE OF APPLICATION [Please tick (✓) at the appropriate category]					
Ordinary (✓)		Convention ()		PCT-NP ()	
Divisional ()	Patent of Addition ()	Divisional ()	Patent of Addition ()	Divisional ()	Patent of Addition ()
3A. APPLICANT(S)					
Name in Full		Nationality	Country of Residence	Address of the Applicant	
J B INSTITUTE OF TECHNOLOGY		Indian	India	NH-72, VILLAGE SHANKARPUR, CHAKRATA ROAD, DEHRADUN, Uttarakhand, 248197, India.	
3B. CATEGORY OF APPLICANT [Please tick (✓) at the appropriate category]					
Natural Person ()		Other than Natural Person			
		Small Entity ()	Startup ()	Educational Institution (✓)	Others ()
4. INVENTOR(S) [Please tick (✓) at the appropriate category]					
Are all the inventor(s) same as the applicant(s) named above?		Yes ()		No (✓)	
If "No", furnish the details of the inventor(s)					
Name in Full		Nationality	Country of Residence	Address of the Inventor	
Dr. Arun Kumar Maurya		Indian	India	JBIT College of Pharmacy, Dehradun, Uttarakhand.	

Lalit Bisht	Indian	India	JBIT College of Pharmacy, Dehradun, Uttarakhand.		
Dr. Swati Tripathi	Indian	India	Department of Electrical Engineering, JB Institute of Technology, Dehradun.		
5. TITLE OF THE INVENTION					
“A PHYSIOTHERAPY APPARATUS”					
6. AUTHORISED REGISTERED PATENT AGENT(S)			IN/PA No.	IN/PA: 4266	
			Name	Anuj Raturi	
			Mobile No.	+91-9808414112	
7. ADDRESS FOR SERVICE OF APPLICANT IN INDIA			Name	Anuj Raturi	
			Postal Address	Gyananand Bhawan, Kalinka Vihar Lane No. 3, Majrimafi, IIP Mohkampur Kala-248005, Dehradun, Uttarakhand, India.	
			Telephone	N/A	
			Mobile No.	+91-9808414112	
			Fax No.	N/A	
			E-mail ID	anuj.mechanical19@gmail.com	
8. IN CASE OF APPLICATION CLAIMING PRIORITY OF APPLICATION FILED IN CONVENTION COUNTRY, PARTICULARS OF CONVENTION APPLICATION					
Country	Application Number	Filing date	Name of the applicant	Title of the	IPC (as classified in the convention country)
Nil	Nil	Nil	Nil	Nil	Nil
9. IN CASE OF PCT NATIONAL PHASE APPLICATION, PARTICULARS OF INTERNATIONAL APPLICATION FILED UNDER PATENT CO-OPERATION TREATY (PCT)					
International application number			International filing date		
Nil			Nil		
10. IN CASE OF DIVISIONAL APPLICATION FILED UNDER SECTION 16, PARTICULARS OF ORIGINAL (FIRST) APPLICATION					
Original (first) application No.			Date of filing of original (first) application		
Nil			Nil		
11. IN CASE OF PATENT OF ADDITION FILED UNDER SECTION 54, PARTICULARS OF MAIN APPLICATION OR PATENT					
Main application/patent No.			Date of filing of main application		

12. DECLARATIONS

(i) Declaration by the inventor(s)



(In case the applicant is an assignee: the inventor(s) may sign herein below or the applicant may upload the assignment or enclose the assignment with this application for patent or send the assignment by post/electronic transmission duly authenticated within the prescribed period).

I/We, the above named inventor(s) is/are the true & first inventor(s) for this Invention and declare that the applicant(s) herein is/are my/our assignee or legal representative.

Dated this: November 20, 2022.

Signature(s)

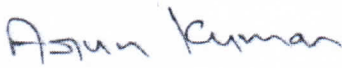
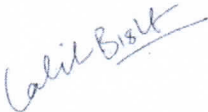
Name(s) of the signatory

		
Dr. Arun Kumar Maurya	Lalit Bisht	Dr. Swati Tripathi

(ii) Declaration by the applicant(s) in the convention country

(In case the applicant in India is different than the applicant in the convention country: the applicant in the convention country may sign herein below or applicant in India may upload the assignment from the applicant in the convention country or enclose the said assignment with this application for patent or send the assignment by post/electronic transmission duly authenticated within the prescribed period)

I/We, the applicant(s) in the convention country declare that the applicant(s) herein is/are my/our assignee or legal representative.

Dated this: (Not applicable)

- a) Signature(s)
- b) Name(s) of the signatory

(iii) Declaration by the applicant(s)

I/We the applicant(s) hereby declare(s) that: -

- I am/ We are in possession of the above-mentioned invention.
- The complete specification relating to the invention is filed with this application.
- ~~The invention as disclosed in the specification uses the biological material from India and the necessary permission from the competent authority shall be submitted by me/us before the grant of patent to me/us.~~
- There is no lawful ground of objection(s) to the grant of the Patent to me/us.
- ~~I am/we are the true & first inventor(s).~~
- I am/we are the assignee or legal representative of true & first inventor(s).
- ~~The application or each of the applications, particulars of which are given in Paragraph 8, was the first application in convention country/countries in respect of my/our invention(s).~~
- ~~I/We claim the priority from the above mentioned application(s) filed in convention country/countries and state that no application for protection in respect of the invention had been made in a convention country before that date by me/us or by any person from which I/We derive the title.~~
- ~~My/our application in India is based on international application under Patent Cooperation Treaty (PCT) as mentioned in Paragraph 9.~~
- ~~The application is divided out of my /our applications particulars of which is given in Paragraph 10 and pray that this application may be treated as deemed to have been filed on DD/MM/YYYY under section 16 of the Act.~~
- ~~The said invention is an improvement in or modification of the invention particulars of which are given in Paragraph 11.~~

13. FOLLOWING ARE THE ATTACHMENTS WITH THE APPLICATION
(a) Form 2

Item	Details	Fee	Remarks
Complete #	No. of pages: 11		(Total 15 pages)
No. of Claim(s)	No. of claims 07 and No. of pages: 02		
Abstract	No. of pages: 01		
No. of Drawing(s)	No. of drawings No. 01 of pages: 01		

In case of a complete specification, if the applicant desires to adopt the drawings filed with his provisional specification as the drawings or part of the drawings for the complete specification under rule 13(4), the number of such pages filed with the provisional specification are required to be mentioned here.

- (b) Complete specification (in conformation with the international application)/as amended before the International Preliminary Examination Authority (IPEA), as applicable.
- (c) Drawings (in conformation with the international application)/as amended before the International Preliminary Examination Authority (IPEA), as applicable (2 copies).
- (d) Statement and Undertaking on Form 3
- (e) Declaration of Inventorship on Form 5
- (f) Power of Authority Form 26
- (g) Request for Early Publication on Form 9
- (h) Request for Examination on Form 18

**Total fee - in cash/Banker's Cheque/Bank Draft Bearing NO..... Date.....on
..... Bank**

Dated this: November 20, 2022.

ON BEHALF OF APPLICANT

- a) Signature(s)
- b) Name(s) of the signatory

Signature: 

Name: Anuj Raturi [IN/PA: 4266]

(AGENT FOR THE APPLICANT)

To,
The Controller of Patents
The Patent Office, at New Delhi, Mumbai, Kolkata, Chennai

Note: -

- * Repeat boxes in case of more than one entry.
- * To be signed by the applicant(s) or by authorized registered patent agent otherwise where mentioned.
- * Tick (✓)/cross (x) whichever is applicable/not applicable in declaration in paragraph-12.
- * Name of the inventor and applicant should be given in full, family name in the beginning.
- * Strike out the portion which is/are not applicable.
- * For fee: See First Schedule;

FORM 2
THE PATENTS ACT, 1970
(39 of 1970)
&
The Patents Rules, 2003

COMPLETE SPECIFICATION
(See section 10 and rule 13)

Title: "A PHYSIOTHERAPY APPARATUS"

Applicant(s):

Name: JB Institute of Technology

Nationality: Indian

Address: 23 Milestone, NH-07, Chakrata Road, Shankarpur, Dehradun,
Uttarakhand, India.

PREAMBLE TO THE DESCRIPTION:

The following specification particularly describes the invention and the manner in which it is to be performed.

FIELD OF THE INVENTION:

The present invention relates to a physiotherapy apparatus. More particularly the present invention relates to an apparatus for eradicating the stiffness of elbows and wrists.

BACKGROUND OF THE INVENTION:

5 The background description embraces information that may be convenient in understanding the present invention. It is not an admission that any of the information provided herein is prior art or relevant to the presently claimed invention, or that any publication specifically or implicitly referenced is prior art.

A number of different type of the assemblies and apparatus for physiotherapy are
10 available in the prior art. For example, the following prior arts are provided for their supportive teachings and are all incorporated by reference:

Prior art document CN112774014A discloses, a rehabilitation physiotherapy device for wrists, which comprises a plurality of physiotherapy units distributed at intervals, physiotherapy belts spirally wound on the outer sides of the physiotherapy
15 units and a buffer base positioned on the outer sides of the physiotherapy belts, wherein the adjacent physiotherapy units are connected through elastic belts, the physiotherapy units are in an annular belt shape, a medicine bag with a closed part is arranged in each physiotherapy unit, and one side, opposite to a human body, of the medicine bag is provided with a one-way air hole; the buffer base and the
20 medicine bag are both arranged into elastic structures, and the buffer base protrudes out of the surface of the physiotherapy belt; when the buffer base extrudes the medicine bag, the air hole is opened; the physiotherapy belt is movably arranged on the outer side surface of the physiotherapy unit in a penetrating way. The invention has strong functionality and convenient use, and can be widely applied to the
25 technical field of rehabilitation physiotherapy devices. While present invention relates to an apparatus for eradicating the stiffness of elbows and wrists which is completely different from said prior art.

Another prior art document US20030105416 discloses a passive therapy device useful for bringing back mobility to the wrist, forearm and/or elbow after immobilization. The device provides therapy to restricted tissue in the wrist, forearm and/or elbow while applying passive tension during therapy. The therapy device is able to readily convert from supination therapy to pronation therapy. In addition, the device can be converted for either right hand use or left hand use. While present invention relates to an apparatus for eradicating the stiffness of elbows and wrists which is completely different from said prior art.

Yet another prior art document US7491186B2 discloses an orthosis and method for the treatment of wrist and elbow illnesses. The orthosis includes a first cuff adapted to be secured to a hand of a user. A second cuff is adapted to be secured to an upper arm portion above an elbow joint of the user. The first cuff and the second cuff include a first attachment point and a second attachment point, respectively. The orthosis also includes a resilient member having a first end and a second end opposing the first end. The first end of the resilient member is attached to the first attachment point of the first cuff. The second end of the resilient member is attached to the second attachment point of the second cuff. The first attachment point and the second attachment point are positioned such that a wrist extension force and a forearm extension force are opposed by a counteracting force produced by the resilient member. The counteracting force opposes the rotation of the forearm relative to the upper arm about the elbow joint and maintains the wrist in a substantially flexion position. While present invention relates to an apparatus for eradicating the stiffness of elbows and wrists which is completely different from said prior art.

All the above cited prior arts uses complex and costly mechanisms for the physiotherapy of elbow and wrists. Wherein, the present invention discloses a

physiotherapy apparatus for eradicating the stiffness of elbows and wrists which has all the advantages over the prior art and none of the disadvantages.

OBJECTS OF THE PRESENT INVENTION:

5 The objects of the present invention, which at least one embodiment herein satisfy are as listed herein below.

The main object of the present invention is to provide an apparatus for eradicating the stiffness of joints specifically for the elbow and wrist.

10 Another object of the present invention is to provide an apparatus for eradicating the stiffness of joints, which is economic in use because there is no use of electronic equipment.

Yet another object of the present invention is to provide an apparatus for eradicating the stiffness of joints, which is ailing person friendly and simple in use.

15 Yet another object of the present invention to provide an apparatus for eradicating the stiffness of joints wherein, apparatus is durable and requires less skill to maintain.

SUMMARY OF THE INVENTION:

The present invention relates to an exercising apparatus. More particularly the present invention relates to an apparatus for eradicating the stiffness of elbows and wrists.

20 The main aspect of the present invention relates to an apparatus for eradicating the stiffness of elbows and wrists. The apparatus includes a ball bearing pulley. An oval suspend configured with the ball bearing pulley for hanging the ball bearing pulley. A length of cable having a first end and a second end, and the cable is configured around the ball bearing pulley from a center of the cable such that a first half of the
25 cable is at one side and second half of the cable is at a second side of the ball bearing

pulley. A first lever coupled with the first end, and a second lever coupled with the second end. A plurality of transverse member aligned in between the first half and the second half of the cable.

5 In an another aspect, the oval suspend may be configured to hang the apparatus at any suitable flat vertical surface such as wall.

Yet in an another aspect, an ailing person required to hold the first lever and the second lever through his hands.

10 Still in an another aspect, an ailing person required to seated aside of the ball bearing pulley and prolongs a first arm of an injured elbow to the side such that a descendant pull applied by a second arm of unscathed elbow raises the first arm of the injured elbow in a reciprocating manner.

Still in an another aspect, the plurality of transverse members may facilitate the ailing person for performing wrist exercises.

15 Still in an another aspect, each of the plurality of transverse members may be spaced uniformly apart from consecutive transverse member.

Still in an another aspect, each of the plurality transverse members may be configured with the first half and second half of the cable through circular shaped pieces wherein said circular shaped pieces are free for rotation.

20 Other objects, aspects and advantages of the invention will further come to be more apparent in the detailed description of the preferred embodiments which can be read jointly with the accompanying exemplary drawings and numeral representation of the components.

BRIEF DESCRIPTION OF THE DRAWING(S):

It is to be noted, however, that the appended drawings illustrate only typical embodiments of this invention and are therefore not to be considered for limiting of its scope, for the invention may admit to other equally effective embodiments.

FIG. 1 depicts an exemplary representation of a stiffness eradicating apparatus for joints, in accordance with an embodiment of the present invention.

DETAILED DESCRIPTION OF THE INVENTION:

In the following detailed description, reference is made to the accompanying drawings which form a part hereof, and in which is shown by way of illustration specific embodiments in which the invention may be practiced. These embodiments are described in sufficient detail to enable those skilled in the art to practice the invention, and it is to be understood that the embodiments may be combined, or that other embodiments may be utilized and that structural and logical changes may be made without departing from the spirit and scope of the present invention. The following detailed description is, therefore, not to be taken in a limiting sense, and the scope of the present invention is defined by the appended claims and their equivalents.

The present invention is described in brief with reference to the accompanying drawings. Now, refer in more detail to the exemplary drawings for the purposes of illustrating non-limiting embodiments of the present invention.

As used herein, the term "comprising" and its derivatives including "comprises" and "comprise" include each of the stated integers or elements but does not exclude the inclusion of one or more further integers or elements.

As used herein, the singular forms "a", "an", and "the" include plural referents unless the context clearly dictates otherwise. For example, reference to "a

apparatus" encompasses a single apparatus as well as two or more apparatus, and the like.

As used herein, the terms "for example", "like", "such as", or "including" are meant to introduce examples that further clarify more general subject matter. Unless
5 otherwise specified, these examples are provided only as an aid for understanding the applications illustrated in the present disclosure, and are not meant to be limiting in any fashion.

As used herein, the terms "may", "can", "could", or "might" be included or have a characteristic, that particular component or feature is not required to be included or
10 have the characteristic.

Exemplary embodiments will now be described more fully hereinafter with reference to the accompanying drawings, in which exemplary embodiments are shown. These exemplary embodiments are provided only for illustrative purposes and so that this disclosure will be thorough and complete and will fully convey the
15 scope of the invention to those of ordinary skill in the art. The invention disclosed may, however, be embodied in many different forms and should not be construed as limited to the embodiments set forth herein.

Various modifications will be readily apparent to persons skilled in the art. The general principles defined herein may be applied to other embodiments and
20 applications without departing from the spirit and scope of the invention. Moreover, all statements herein reciting embodiments of the invention, as well as specific examples thereof, are intended to encompass both structural and functional equivalents thereof. Additionally, it is intended that such equivalents include both currently known equivalents as well as equivalents developed in the future (i.e., any
25 elements developed that perform the same function, regardless of structure). Also, the terminology and phraseology used is for the purpose of describing exemplary embodiments and should not be considered limiting. Thus, the present invention is

to be accorded the widest scope encompassing numerous alternatives, modifications and equivalents consistent with the principles and features disclosed. For purpose of clarity, details relating to technical material that is known in the technical fields related to the invention have not been described in detail so as not
5 to unnecessarily obscure the present invention.

Thus, for example, it will be appreciated by those of ordinary skill in the art that the diagrams, schematics, illustrations, and the like represent conceptual views or processes illustrating systems and methods embodying this invention. The functions of the various elements shown in the figures may be provided through the
10 use of dedicated hardware as well as hardware capable of executing associated software. Similarly, any switches shown in the figures are conceptual only. Their function may be carried out through the operation of program logic, through dedicated logic, through the interaction of program control and dedicated logic, or even manually, the particular technique being selectable by the entity implementing
15 this invention. Those of ordinary skill in the art further understand that the exemplary hardware, software, processes, methods, and/or operating systems described herein are for illustrative purposes and, thus, are not intended to be limited to any particular named element.

Each of the appended claims defines a separate invention, which for infringement
20 purposes is recognized as including equivalents to the various elements or limitations specified in the claims. Depending on the context, all references below to the "invention" may in some cases refer to certain specific embodiments only. In other cases, it will be recognized that references to the "invention" will refer to subject matter recited in one or more, but not necessarily all, of the claims.

25 The present invention relates to an exercising apparatus. More particularly the present invention relates to an apparatus for eradicating the stiffness of elbows and wrists.

The present invention relates to an apparatus for eradicating the stiffness of elbows and wrists. The apparatus includes a ball bearing pulley. An oval suspend configured with the ball bearing pulley for hanging the ball bearing pulley. A length of cable having a first end and a second end, and the cable is configured around the ball bearing pulley from a center of the cable such that a first half of the cable is at one side and second half of the cable is at a second side of the ball bearing pulley. A first lever coupled with the first end, and a second lever coupled with the second end. A plurality of transverse member aligned in between the first half and the second half of the cable.

10 In an embodiment, the oval suspend may be configured to hang the apparatus at any suitable flat vertical surface such as wall.

In an embodiment, an ailing person required to hold the first lever and the second lever through his hands.

15 In an embodiment, an ailing person required to seated aside of the ball bearing pulley and prolongs a first arm of an injured elbow to the side such that a descendant pull applied by a second arm of unscathed elbow raises the first arm of the injured elbow in a reciprocating manner.

In an embodiment, the plurality of transverse members may facilitate the ailing person for performing wrist exercises.

20 In an embodiment, each of the plurality of transverse members may be spaced uniformly apart from consecutive transverse member.

In an embodiment, each of the plurality transverse members may be configured with the first half and second half of the cable through circular shaped pieces.

FIG. 1 depicts an exemplary representation of a stiffness eradicating apparatus for joints specifically for elbow and wrist, in accordance with an embodiment of the present invention.

As depicted in FIG. 1, an apparatus (100) for eradicating joints stiffness specifically for elbow and wrist can includes a ball bearing pulley (102). An oval suspend (104) can be configured with the ball bearing pulley (102) for locating the ball bearing pulley on desired place. The ball bearing pulley (102) can be mounted with any
5 suitable vertical surface such as wall wherein there is a strong back support. A length of cable (106) can be configured around the ball bearing pulley (102) in such a way that the first half of the cable (106) and second half of the cable (106) maintain an equidistant length at both sides of the ball bearing pulley (102).

In an embodiment, a first lever (108) can be attached with the first end, and a second
10 lever (114) can be attached with the second end of the cable (106). An ailing person can be seated adjacent to the ball bearing pulley and can hold the first lever and the second lever through his/her hands. The ailing person can extend his/her first arm of an injured elbow to the side such that a descending pull applied by his/her second arm of intact elbow raises the first arm of the injured elbow in an abduction manner.

15 In an embodiment, the apparatus (100) can include a plurality of transverse member (110) that can be configured between the first half and the second half of the cable (106). Each of the plurality of transverse members (110) can be spaced uniformly apart from consecutive transverse member. In an embodiment, the plurality of transverse members (110) can facilitate the ailing person for performing wrist
20 exercises. In an embodiment, each the plurality of transverse members can be configured with the first half and second half of the cable through circular shaped pieces (112).

The present invention provides a specific featured exercising apparatus. More particularly the present invention provides an apparatus for eradicating the stiffness
25 of elbows and wrists which has a number of advantages.

The present invention provides an apparatus for eradicating the stiffness of joints specifically for the elbow and wrist.

The present invention provides an apparatus for eradicating the stiffness of joints, which is economic in use as there is no use of electronic equipment.

- 5 The present invention provides an apparatus for eradicating the stiffness of joints, which is friendly to ailing person and simple in use.

The present invention provides provide an apparatus for eradicating the stiffness of joints wherein, apparatus is durable and requires less skill to maintain.

- 10 **Dated:** 20th Day of November, 2022.

ON BEHALF OF APPLICANT

Signature: 

15 **Name:** Anuj Raturi [IN/PA: 4266]

(AGENT FOR THE APPLICANT)

20

CLAIM(S):

I/WE Claim:

1. A physiotherapy apparatus comprising:
 - a ball bearing pulley (102);
 - 5 an oval suspend configured with the ball bearing pulley for hanging the apparatus (100);
 - a length of cable (106) having a first end and a second end, and the cable (106) is configured around the ball bearing pulley in such a way that the first half of the cable and second half of the cable maintain an equidistant length
 - 10 at both sides of the ball bearing pulley;
 - a first lever (108) and a second lever (114) attached with the left and right ends of the cable (106) respectively;
 - a plurality of transverse member (110) configured between the first half and the second half of the cable.
- 15 2. The physiotherapy apparatus as claimed in claim 1, wherein the oval suspend (104) is configured to hang the apparatus in a sliding free manner on any vertical surface.
3. The physiotherapy apparatus as claimed in claim 1, wherein first lever (108) and the second lever (114) are configured to hold by the hands of ailing
- 20 person.
4. The physiotherapy apparatus as claimed in claim 1, wherein first lever and the second lever are configured to operate by the ailing person either in standing or sitting position.
5. The physiotherapy apparatus as claimed in claim 1, wherein the plurality of
- 25 transverse members is configured with the first half and second half of the cable through circular shaped pieces (112).

- 5
6. The physiotherapy apparatus as claimed in claim 5, wherein the plurality of transverse members is configured to provide wrist exercise.
 7. The physiotherapy apparatus as claimed in claim 1, wherein the ball bearing pulley (102) specifically configured to provide smooth movement of the cable (106).

Dated: 20th Day of November, 2022.

ON BEHALF OF APPLICANT

Signature: 

Name: Anuj Raturi [IN/PA: 4266]

(AGENT FOR THE APPLICANT)

ABSTRACT

TITLE: A PHYSIOTHERAPY APPARATUS

The present invention relates to an apparatus for eradicating the stiffness of joints specifically the elbow and wrist. Said apparatus comprises of a ball bearing pulley; an oval suspend configured with the ball bearing pulley to form a hanging assembly; A length of cable configured around the pulley; a first lever and a second lever attached with the both ends of the ball bearing pulley and a plurality transverse members configured in between the first half and the second half of the cable.

Dated: 20th Day of November, 2022.

ON BEHALF OF APPLICANT

Signature: 

Name: Anuj Raturi [IN/PA: 4266]

(AGENT FOR THE APPLICANT)

FORM 3
THE PATENTS ACT,
 1970 (39 of 1970)
 and
THE PATENTS RULES, 2003
STATEMENT AND UNDERTAKING UNDER
SECTION 8
 (See section 8; Rule 12)

1. Name & address of the applicant(s). We, **J B INSTITUTE OF TECHNOLOGY** of the address **NH-72, VILLAGE SHANKARPUR, CHAKRATA ROAD, DEHRADUN, Uttarakhand, 248197, India** hereby declare:
 (i) that we who have made this Application No. **202211**_____dated **20/11/2022** alone, made for the same/ substantially same invention, application(s) for patent in the other countries, the particulars of which are given below:

Name of the Country	Date of Application	Application No.	Status of Application	Date of publication	Date of Grant
---------------------	---------------------	-----------------	-----------------------	---------------------	---------------

Details attached as ANNEXURE

2. Name of the assignee (ii) that the rights in the application(s) has/have been assigned to **J B INSTITUTE OF TECHNOLOGY** that we undertake that up to the date of grant of the patent by the Controller, we would keep him informed in writing the details regarding corresponding applications for patents filed outside India within six months from the date of filing of such application.
Dated this: November 20, 2022.

3. To be signed by the applicant or his authorized registered patent agent.

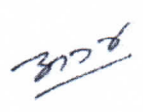
Signature: 
Name: Anuj Raturi [IN/PA: 4266]
(AGENT FOR THE APPLICANT)

4. Name of the natural person who has signed. **Anuj Raturi**

To,
 The Controller of Patents,
 The Patent Office, **Delhi**

Note.- Strike out whichever is not applicable;

ANNEXURE TO FORM-3

Title of Invention: "A PHYSIOTHERAPY APPARATUS"

Application No. 202211_____ Filed on: 20/11/2022

Applicant(s): J B INSTITUTE OF TECHNOLOGY

Country	Application date	Application No.	Status of the Application	Date of Pub. / Pub. Number	Date of grant / Grant Number
N/A	N/A	N/A	N/A	N/A	N/A

*N/A (Not applicable)

Dated this: November 18, 2022.

Signature: 

Name: Anuj Raturi [IN/PA: 4266]

(AGENT FOR THE APPLICANT)

FORM 5

**THE PATENTS ACT, 1970
(39 of 1970)
&
THE PATENT RULES, 2003
DECLARATION AS TO INVENTORSHIP**

[See Section 10(6) and Rule 13(6)]

We, **J B INSTITUTE OF TECHNOLOGY** having institution address at **NH-72, VILLAGE SHANKARPUR, CHAKRATA ROAD, DEHRADUN, UTTARAKHAND, 248197, INDIA**, hereby declare that the true and first inventors of the invention disclosed in the complete specification filed in pursuance of our Application Titled "**A PHYSIOTHERAPY APPARATUS**" are:

Name: Dr. Arun Kumar Maurya

Nationality: Indian

Address: JBIT College of Pharmacy, Dehradun, Uttarakhand.

Name: Lalit Bisht

Nationality: Indian

Address: JBIT College of Pharmacy, Dehradun, Uttarakhand.

Name: Dr. Swati Tripathi

Nationality: Indian

Address: Department of Electrical Engineering, JB Institute of Technology, Dehradun.

Dated this: November 20, 2022.

Signature & Name:

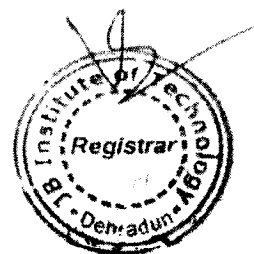

Registrar

J B Institute of Technology

To,
The Controller of Patents
The Patent Office, at Delhi.

FORM 9

The Patent ACT, 1970 (39 of 1970)

&

The Patents Rule, 2003

Request for Publication

[See section 11A (2), Rule 24A]

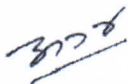
1. Name, address and nationality of the applicants:	We, J B INSTITUTE OF TECHNOLOGY Address: NH-72, VILLAGE SHANKARPUR, CHAKRATA ROAD, DEHRADUN, Uttarakhand, 248197 India. Nationality: Indian
2. To be signed by the applicant or his authorized registered patent agent	Hereby request for early publication of our application Titled: "A PHYSIOTHERAPY APPARATUS" filed herewith under section 11A(2) of the Act.
3. Name of the natural person who signed. Dated: November 20, 2022.	Signature:  Name: Anuj Raturi [IN/PA: 4266] (AGENT FOR THE APPLICANT)

To,
The Controller of Patents
The Patent Office at, New Delhi.

FORM 28

THE PATENT ACT, 1970 (39 OF 1970)

&

THE PATENTS RULES, 2003

TO BE SUBMITTED BY AN EDUCATIONAL INSTITUTION

[See rules 2 (ca) and 7]

We, **J B INSTITUTE OF TECHNOLOGY** having Nationality of India of the address- **NH-72, VILLAGE SHANKARPUR, CHAKRATA ROAD, DEHRADUN, Uttarakhand, 248197, India.** Applicant in respect of the patent application titled "**A PHYSIOTHERAPY APPARATUS**" & application no.202211_____,

hereby declare that we are an educational institution in accordance with rule 2(ca) and submit the following document(s) as proof;

i) Certificate/proof of university recognized under/Central/State government.

The information provided herein is correct to the best of our knowledge and belief.

Dated this: November 20, 2022.

Signature: 

Name: Anuj Raturi [IN/PA: 4266]

(AGENT FOR THE APPLICANT)

To,
The Controller of Patents,
The Patent Office, at Delhi.

FORM 28

THE PATENT ACT, 1970 (39 OF 1970)

&

THE PATENTS RULES, 2003

TO BE SUBMITTED BY AN EDUCATIONAL INSTITUTION

[See rules 2 (ca) and 7]

We, **J B INSTITUTE OF TECHNOLOGY** having Nationality of India of the address- **NH-72, VILLAGE SHANKARPUR, CHAKRATA ROAD, DEHRADUN, Uttarakhand, 248197, India.** Applicant in respect of the patent application titled "**A PHYSIOTHERAPY APPARATUS**" & application no.202211_____,

hereby declare that we are an educational institution in accordance with rule 2(ca) and submit the following document(s) as proof;

i) Certificate/proof of university recognized under/Central/State government.

The information provided herein is correct to the best of our knowledge and belief.

Dated this: November 20, 2022.

Signature: 

Name: Anuj Raturi [IN/PA: 4266]

(AGENT FOR THE APPLICANT)

To,

The Controller of Patents,

The Patent Office, at Delhi.

All India Council for Technical Education

(A Statutory body under Ministry of Education, Govt. of India)

Nelson Mandela Marg, Vasant Kunj, New Delhi-110070 Website: www.aicte-india.org



APPROVAL PROCESS 2022-23

Extension of Approval (EoA)

F.No. Northern/1-10968838042/2022/EOA

Date: 29-Jul-2022

To,

The Secretary(Technical Education)
Govt. of Uttarakhand, Dehradun Sectt.,
4 Subhash Road, Dehradun-248001

Sub: Extension of Approval for the Academic Year 2022-23

Ref: Application of the Institution for Extension of Approval for the Academic Year 2022-23

Sir/Madam,

In terms of the provisions under the All India Council for Technical Education (Grant of Approvals for Technical Institutions) Regulations, 2022 Notified on 4th February, 2022 and amended on 24th February 2022 and norms standards, procedures and conditions prescribed by the Council from time to time, I am directed to convey the approval to

Permanent Id	1-8461364	Application Id	1-10968838042
Name of the Institution	J B INSTITUTE OF TECHNOLOGY	Name of the Society/Trust	JAI BHAGWAN EDUCATIONAL SOCIETY
Institution Address	NH-72, VILLAGE SHANKARPUR, CHAKRATA ROAD, DEHRADUN, DEHRADUN, DEHRADUN, Uttarakhand, 248197	Society/Trust Address	17 MANDIR MARG, VASANT VIHAR ENCLAVE DEHARDUN, DEHRADUN, DEHRADUN, Uttarakhand, 248001
Institution Type	Private-Self Financing	Region	Northern
Year of Establishment	2009		

Opted for Introduction of New Program/Level	Yes	Introduction of Program/Level Approved or Not	Approved
---	-----	---	----------

To conduct following Courses with the Intake indicated below for the Academic Year 2022-23

Level	Program	Course	Affiliating Body (University /Body)	Intake Approved for 2021-22	Intake Approved for 2022-23	NRI Approval Status	FN / Gulf quota/ OCI/ Approval Status
DIPLOMA	ENGINEERING AND TECHNOLOGY	CIVIL ENGINEERING	Directorate Of Technical Education, Srinagar(Garhwal)	60	60	No	No
DIPLOMA	ENGINEERING AND TECHNOLOGY	ELECTRICAL ENGINEERING	Directorate Of Technical Education, Srinagar(Garhwal)	60	60	No	No

Level	Program	Course	Affiliating Body (University /Body)	Intake Approved for 2021-22	Intake Approved for 2022-23	NRI Approval Status	FN / Gulf quota/ OCI/ Approval Status
DIPLOMA	ENGINEERING AND TECHNOLOGY	MECHANICAL ENGINEERING	Directorate Of Technical Education, Srinagar(Garhwal)	60	60	No	No
UNDER GRADUATE	ENGINEERING AND TECHNOLOGY	ARTIFICIAL INTELLIGENCE AND MACHINE LEARNING	Uttarakhand Technical University, Dehradun	60	30	NA	NA
UNDER GRADUATE	ENGINEERING AND TECHNOLOGY	CIVIL ENGINEERING	Uttarakhand Technical University, Dehradun	60	60	No	No
UNDER GRADUATE	ENGINEERING AND TECHNOLOGY	COMPUTER SCIENCE & ENGINEERING	Uttarakhand Technical University, Dehradun	60	90	NA	NA
UNDER GRADUATE	ENGINEERING AND TECHNOLOGY	ELECTRICAL ENGINEERING	Uttarakhand Technical University, Dehradun	30	30	No	No
UNDER GRADUATE	ENGINEERING AND TECHNOLOGY	ELECTRONICS & COMMUNICATION ENGG	Uttarakhand Technical University, Dehradun	30	30	No	No
UNDER GRADUATE	ENGINEERING AND TECHNOLOGY	MECHANICAL ENGINEERING	Uttarakhand Technical University, Dehradun	60	60	No	No
POST GRADUATE	ENGINEERING AND TECHNOLOGY	COMPUTER SCIENCE & ENGINEERING	Uttarakhand Technical University, Dehradun	24	24	No	No
POST GRADUATE	MANAGEMENT	MBA	Uttarakhand Technical University, Dehradun	0	60##	No	No

Approved New Course(s)

It is mandatory to comply with all the essential requirements as given in APH 2022-23 (Appendix 6)

Important Instructions

1. The State Government/ UT/ Directorate of Technical Education/ Directorate of Medical Education shall ensure that 10% of reservation for Economically Weaker Section (EWS) as per the reservation policy for admission, operational from the Academic year 2019-20 is implemented without affecting the reservation percentages of SC/ ST/ OBC (NCL)/ General. However, this would not be applicable in the case of Minority Institutions referred to the Clause (1) of Article 30 of Constitution of India. Such Institution shall be permitted to increase in annual permitted strength over a maximum period of two years.
2. The Institution offering courses earlier in the Regular Shift, First Shift, Second Shift/Part Time are now amalgamated as total intake and shall have to fulfil all facilities such as Infrastructure, Faculty and other requirements as per the norms specified in the Approval Process Handbook 2022-23 for the Total Approved Intake. Further, the Institutions Deemed to be Universities/ Institutions having Accreditation/ Autonomy status shall have to maintain the Faculty: Student ratio as specified in the Approval Process Handbook. All such Institutions/ Universities shall have to create the necessary Faculty, Infrastructure and other facilities WITHIN 2 YEARS to fulfil the norms based on the Affidavit submitted to AICTE beginning with the Academic Year 2022-23
3. Strict compliance of Anti-Ragging Regulation, Establishment of Committee for SC/ ST, Establishment of Internal Complaint Committee (ICC), Establishment of Online Grievance Redressal Mechanism, Barrier Free Built Environment for disabled and elderly persons, Fire and Safety Certificate should be maintained as Approval Process Handbook and provisions made in AICTE Regulation notified from time to time.
4. In case of any differences in content in this Computer generated Extension of Approval Letter, the content/information as approved by the Executive Council / General Council as available on the record of AICTE shall be final and binding.

Pharmacy Institute: In compliance with the order dated 05.03.2020 passed by the Hon'ble Supreme Court of India in Transferred Petitions (CIVIL) No 87-101 of 2014, for the existing institutions offering courses in Pharmacy Programme, approval of Pharmacy Council of India (PCI) is mandatory and AICTE approval is NOT required. The requirements for running the Programme (Diploma / UG / PG) such as Land & Build-up Area, Student-faculty ratio, Intake etc. will be as per the respective regulatory body (PCI). In case of any inconsistency in the course name and intake for EoA issued by AICTE and the approval by PCI, the approval of PCI shall prevail.

Architecture Institute: In compliance with the order dated 08.11.2019 passed by the Hon'ble Supreme Court of Indian CA No.364/ 2005, for the existing Institutions offering Courses in Architecture Programme, approval by the Council of Architecture (CoA) is mandatory and AICTE approval is NOT required. The requirements for running the Programme (Diploma / UG / PG) such as Land & Build-up Area, Student-faculty ratio, Intake etc. will be as per respective regulatory body (CoA). In case of any inconsistency in the course name and intake for EoA issued by AICTE and the approval by CoA, the approval of CoA shall prevail.

Deemed to be University: Institutions Deemed to be Universities (Running Technical Education Programmes), it is mandatory to have AICTE approval from the Academic Year 2018-19 in compliance of the Hon'ble Supreme Court Order dated 03-11-2017 passed in CA No.17869- 17870 /2017.

Prof.Rajive Kumar
Member Secretary, AICTE

Copy to:

1. **The Director Of Technical Education**, Uttarakhand**
2. **The Registrar**,
Directorate Of Technical Education, Srinagar(Garhwal)**
3. **The Principal / Director,
J B INSTITUTE OF TECHNOLOGY
Nh-72, Village Shankarpur, Chakrata Road, Dehradun,
Dehradun,Dehradun,
Uttarakhand,248197**
4. **The Secretary / Chairman,
17 MANDIR MARG, VASANT VIHAR ENCLAVE
DEHARDUN
DEHRADUN,DEHRADUN**

Uttarakhand.248001

5. **The Regional Officer,**
All India Council for Technical Education
Govt. Polytechnic Campus
Adjoining Directorate of Technical Education
Vikas Nagar, Kanpur-208 002, Uttar Pradesh

6. **Guard File(AICTE)**

Note: Validity of the Course details may be verified at <http://www.aicte-india.org/>

** Individual Approval letter copy will not be communicated through Post/Email. However, consolidated list of Approved Institutions(bulk) will be shared through official Email Address to the concerned Authorities mentioned above.

This is a computer generated Statement. No signature Required



प्रेषक,

डा० रंजीत कुमार सिन्हा
सचिव श्री राज्यपाल/कुलाधिपति।

सेवा में,

कुलपति,
वीर माधो सिंह मण्डारी उत्तराखण्ड प्रौद्योगिकी विश्वविद्यालय,
सुन्दोवाला, देहरादून।

राज्यपाल/कुलाधिपति सचिवालय उत्तराखण्ड :

देहरादून : दिनांक : 3 अक्टूबर, 2022

महोदय,

कृपया विश्वविद्यालय के पत्र सं०-2052 व 2055, दिनांक 07-01-2022 का सन्दर्भ ग्रहण करने का कष्ट करें।

2. उपरोक्त सन्दर्भ के सम्बन्ध में मुझे यह कहने का निदेश हुआ है कि नियामक संस्था, निरीक्षण मण्डल, कुलपति व कुलसचिव, वी०मा०सि०म० उत्तराखण्ड प्रौद्योगिकी विश्वविद्यालय द्वारा प्रदत्त सस्तुति के दृष्टिगत विश्वविद्यालय अधिनियम, 2005 (यथा अद्यतन संशोधित) की धारा-24(2) के अधीन निम्नवत् संस्थान को उसके सम्मुख वर्णित पाठ्यक्रम, सीटों एवं अवधि की अस्थाई सम्यक्ता विस्तारण हेतु छात्रहित में मा० कुलाधिपति द्वारा पूर्वानुमोदन निम्नवत् उपबन्धों के साथ प्रदान किया गया है :-

संस्थान का नाम	पाठ्यक्रम	सीट संख्या प्रति सत्र	शैक्षिक सत्र
1	2	3	4
जे०वी० इस्टीट्यूट ऑफ टेक्नोलॉजी, ग्राम-शंकरपुर, चकराता रोड, देहरादून	बी०टेक० :- 1. Civil Engg. 2. Computer Science & Engg. 3. Electrical Engg. 4. Electronics & Communication Engg. 5. Mechanical Engg. 6. Artificial Intelligence and Machine Learning (New Course-1st Affiliation)	60 60 30 30 60 60	2021-22
	एम०टेक० :- 1. Computer Science & Engg.	24	

(1) विश्वविद्यालय द्वारा संस्थान की Annual Balance Sheet सम्बन्धी साक्ष्य की सत्यापित प्रति प्राप्त कर इस सचिवालय को उपलब्ध कराई जायेगी।

(2) प्राभूति राशि अपूर्ण है। अतः उत्तराखण्ड शासन द्वारा शासनादेश दिनांक 14 दिसम्बर, 2016 द्वारा तथा व्यवसायिक पाठ्यक्रमों हेतु प्राभूति राशि के सम्बन्ध में शासन स्तर पर लिये गये निर्णय का पूर्ण रूप से अनुपालन विश्वविद्यालय व संस्थान द्वारा किया जायेगा, उराके अनुपालन की सूचना से इस सचिवालय को भी अवगत कराया जायेगा।

(3) विश्वविद्यालय द्वारा छात्र/छात्राओं की गुणवत्ता और व्यवहारिक शिक्षा में सुधार के लिए क्या कदम उठाए गये हैं, इसकी सूचना व संस्थानों द्वारा छात्रों की प्रायोगिक शिक्षा और इंटर्नशिप/विजिट के लिए किन समूहों, विभागों एवं कंपनियों के साथ समझौता (Tie-up or MoU) किया गया है, तत्सम्बन्धी अभिलेख एक माह के भीतर अनिवार्य रूप से इस सचिवालय को प्रेषित करना सुनिश्चित करें। अन्यथा की स्थिति में संस्थान की सम्यक्ता निरस्त कर दी जाएगी साथ ही अपेक्षित सत्रों की सम्यक्ता के सम्बन्ध में कोई विचार नहीं किया जायेगा।

क्रमशः.....2 /

(4) विश्वविद्यालय संस्थान द्वारा सोसाइटी/ट्रस्ट पंजीकरण अधिनियम के अन्तर्गत निर्धारित Legal Obligation पूर्ण किये जाने के सम्बन्ध में राश्व संश्लित आरथ्या एक माह के भीतर राज्यपाल सचलवालय को उपलब्ध कराया जाना सुनिश्चित किया जाएगा।

(5) यदि संस्थान द्वारा एक या एक से अधिक विश्वविद्यालय से पाठ्यक्रम की सम्यद्धता प्राप्त की गई हो तो संस्थान समस्त पाठ्यक्रमों की सम्यद्धता को एक साथ रखकर पाठ्यक्रमवार मानक पूर्ण किये जाने के सम्बन्ध में आरथ्या संस्थान द्वारा विश्वविद्यालय को उपलब्ध कराई जाएगी तथा संस्थान से प्राप्त आरथ्या का परीक्षण करते हुए विश्वविद्यालय द्वारा राज्यपाल सचलवालय को उपलब्ध कराई जाएगी।

(6) अग्रततर सत्रों के सम्यद्धता प्रस्ताव नियामक संस्था, विश्वविद्यालय एवं शासन द्वारा निर्धारित मानकों के अनुरूप पूर्ण होने की दशा में ही स्वीकार किये जाएंगे अन्यथा की स्थिति में अपूर्ण प्रस्तावों पर विचार नहीं किया जाएगा, जिराका पूर्ण उत्तरदायित्व विश्वविद्यालय का होगा।

(7) विश्वविद्यालय, नियामक संस्था, विश्वविद्यालय व राज्य सरकार द्वारा निर्धारित सभी मानकों के पूर्ण होने की दशा में ही कार्यपरिषद के अनुमोदन से विहित शर्तों/उपबन्धों के अधीन अस्थायी सम्यद्धता विस्तारण के आदेश निर्गत करे व तत्सम्बन्धी कार्यवाही की सूचना मा0 कुलाधिपति महोदय के अवगतार्थ उपलब्ध कराये।

तदनुसार अग्रततर कार्यवाही सुनिश्चित करे।

भवदीय,

(डॉ० संजीत कुमार सिन्हा)
सचिव श्री राज्यपाल/कुलाधिपति।

संख्या-2852(1)/जी0एस0(शिक्षा)/A4-48(P-II)/2019 तद्दिनांकित।

प्रतिलिपि निम्नलिखित को सूचनार्थ एवं आवश्यक कार्रवाई हेतु प्रेषित -

1. सचिव, तकनीकी शिक्षा विभाग, उत्तराखण्ड शासन।
2. प्राचार्य/निदेशक, संबंधित संस्थान।
3. कम्प्यूटर प्रकोष्ठ/गार्ड फाईल हेतु।

आज्ञा से

(स्वाति एस० मदीरिया)
अपर सचिव श्री राज्यपाल/कुलाधिपति।



सत्यमेव जयते

INDIA NON JUDICIAL

Government of Uttarakhand

e-Stamp

Certificate No. : IN-UK16797909044229U
Certificate Issued Date : 05-Nov-2022 04:19 PM
Account Reference : NONACC (SV)/ uk1210104/ VIKAS NAGAR/ UK-DH
Unique Doc. Reference : SUBIN-UKUK121010439047870669742U
Purchased by : J B INSTITUTE OF TECHNOLOGY
Description of Document : Article Miscellaneous
Property Description : MISC
Consideration Price (Rs.) : 0
(Zero)
First Party : J B INSTITUTE OF TECHNOLOGY
Second Party : NA
Stamp Duty Paid By : J B INSTITUTE OF TECHNOLOGY
Stamp Duty Amount(Rs.) : 100
(One Hundred only)

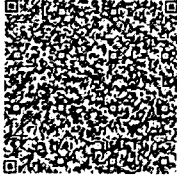

धीरज कुमार सिंघल
(ई-स्टाम्प विक्रेता)
विकासनगर (देहरादून)

Please write or type below this line

FORM 26
THE PATENTS ACT, 1970
(39 OF 1970)
&
The Patent Rules, 2003

FORM FOR AUTHORIZATION OF A PATENT AGENT/ OR ANY PERSON IN A MATTER OR
PROCEEDING UNDER THE ACT
[See Section 127 and 132; Rule 135]

Power of Attorney by J B INSTITUTE OF TECHNOLOGY having address at NH-72, VILLAGE SHANKARPUR, CHAKRATA ROAD, DEHRADUN, Uttarakhand, 248197, India; do hereby authorize Mr. Anuj Raturi [Registered Indian Patent Agent, (IN/PA:4266)] & Adv. Ram Chandra Joshi [Reg. No.: U.A. 2638/04, U.P. 2763/94 (Advocate & Notary)] having office address, as Gyananand Bhawan, Kalinka Vihar, Majrimafi, Lane No.3, IIP Mohkampur Kala-248005, Dehradun, Uttarakhand, India.

Statutory Alert:

1. The authenticity of this Stamp certificate should be verified at www.shrestamp.com or using e-Stamp Mobile App of Stack Holding.
2. Any discrepancy in the details on this Certificate and as available on the website / Mobile App renders it invalid.
3. The onus of checking the legitimacy is on the users of the certificate.
4. In case of any discrepancy please inform the Competent Authority.

FORM 26
THE PATENTS ACT 1970
(39 OF 1970)

&

The Patent Rules, 2003

**Form for Authorization of Patent Agent/ or Any Person in a matter or Proceeding under
the Act**

[See Section 127; and Rule 135]

We, **J B INSTITUTE OF TECHNOLOGY** having address at NH-72, VILLAGE SHANKARPUR, CHAKRATA ROAD, DEHRADUN, Uttarakhand, 248197, India, do hereby authorize **Mr. Anuj Raturi [Registered Indian Patent Agent, (IN/PA:4266)] & Adv. Ram Chandra Joshi [Reg. No.: U.A. 2638/04, U.P. 2763/94 (Advocate & Notary)]** having office address, as Gyananand Bhawan, Kalinka Vihar, Majrimafi, Lane No.3, IIP Mohkampur Kala-248005, Dehradun, Uttarakhand, India, to act on our behalf in connection with the filing and pre & post grant prosecution for the invention titled "**A PHYSIOTHERAPY APPARATUS**" filed in our name and request that all notices, requisitions and communication relating thereto may be sent to such person(s) at the above address unless otherwise specified.

This authorization includes the right to appoint substitutes.

We hereby revoke all previous authorizations, if any made, in respect of the same matter or proceeding.

We hereby assent to the action already taken by the said person in the above matter.

Dated this: November 18, 2022.

Signature & Name:

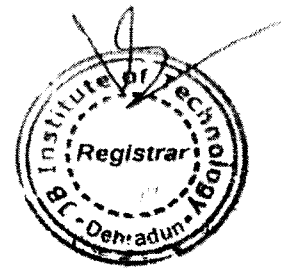

Registrar
J B Institute of Technology

To be stamped under the Indian Stamp Act, 1899 (2 of 1899)

To,
The Controller of Patents
The Patent Office, at Delhi.

To be stamped under the Indian Stamp Act, 1899 (2 of 1899)

Applicants: J B INSTITUTE OF TECHNOLOGY

Total Sheets 01
Sheet no. 1

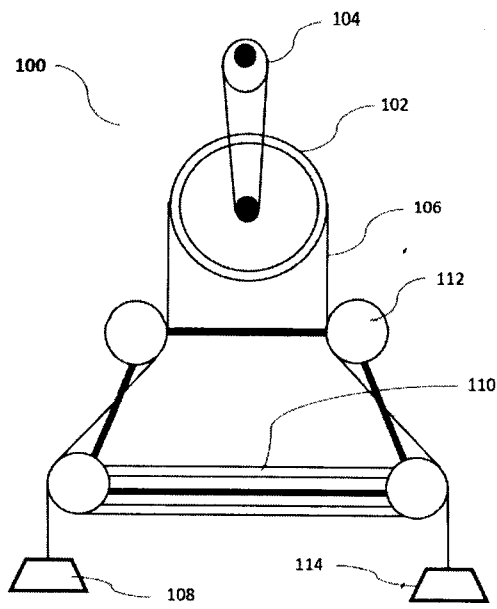

FIG. 1

Dated: November 20, 2022

ON BEHALF OF APPLICANT

Signature:

Name: Amuj Raturi [IN/PA: 4266]
(AGENT FOR THE APPLICANT)